



ALLORO 140 EXTENSIBLE

design Raffaello Galiotto

IT Tavolo allungabile. 140-210 x 100 x 73h cm. Materiale: piano DurelTOP in polipropilene trattato anti-UV, colorato in massa. Gambe in alluminio verniciato. Finitura opaca. Dotato di piedini regolabili. Istruzioni d'uso: posizionare in modo stabile su un suolo piano. Pulire con detergenti non aggressivi e sciacquare con acqua. Tipo di utilizzo: collettività. Prodotto da montare. Prodotto in Italia. Resina riciclabile. Prodotto a norma UNI EN 581/1/3. Avvertenza: rischi di pizzicamento in fase di installazione. Nardi declina ogni responsabilità per danni a persone e/o cose, o al prodotto stesso, causati dall'utilizzo improprio del prodotto.

EN Extensible table. 140-210 x 100 x 73h cm. Material: top DurelTOP in polypropylene with UV additives and uniformly coloured. Legs in coated aluminum. Matt finish. Adjustable height feet. Instructions for use: place on a flat, level area. Wash with mild soap and rinse with water. Typical uses: group gatherings. Assembly required. Made in Italy. Recyclable resin. Product conforms to UNI EN 581/1/3. Note: there is a risk of being pinched during assembly. Nardi declines all responsibility for damage to people and/or things, or to the product itself, caused by improper use of the product.

FR Table extensible. 140-210 x 100 x 73h cm. Matériau: plateau DurelTOP

en polypropylène traité anti-UV et coloré dans la masse. Pieds en aluminium vernis. Effet mat. Vérins de réglage. Instructions d'utilisation: positionner de manière stable sur un sol plan. Nettoyer le produit avec détergent non agressif et rincer avec de l'eau. Type d'utilisation: collectivité. A monter soi-même. Fabriqué en Italie. Résine recyclable. Produit conforme à la norme UNI EN 581/1/3. Avertissement: risques de pincement en cours d'installation. Nardi décline toute responsabilité pour les dommages aux personnes et/ou aux choses, ou au produit lui-même, causés par une mauvaise utilisation du produit.

DE Verlängerbarer Tisch. 140-210 x 100 x 73h cm. Material: DurelTOP Tischplatte aus UV-beständigem Polypropylen, voll durchgefärbt. Beine aus epoxiertem Aluminium. Matt-Effekt. Höhenverstellbaren Füßen. Gebrauchseanleitung: Einsatz auf ebenem Untergrund. Reinigung mit neutralem Reinigungsmittel und mit Wasser nachspülen. Nutzung: Gewerblich. Zusammensetzbarer Artikel. Hergestellt in Italien. Recyclebarer Kunststoff. Produkt entspricht der norm UNI EN 581/1/3. Achtung: Verletzungsgefahr beim Aufbau. Nardi lehnt jede Verantwortung für Schäden an Personen und/oder Gegenständen oder am Produkt selbst ab, die durch unsachgemäße Verwendung des Produkts verursacht werden.

ES Mesa extensible. 140-210 x 100 x 73h cm. Material: tablero DurelTOP en polipropileno tratado anti UV y teñido en masa. Patas en aluminio pintado. Efecto mate. Tacos regulables. Instrucciones de uso: colocar en una superficie plana y estable. Limpiar el producto con detergente suave, aclarándolo posteriormente con agua. Tipo de uso: colectividades. Producto de ensamblar. Fabricado en Italia. Resina reciclable. Fabricado según normativa UNI EN 581/1/3. Advertencia: riesgo de pellizcarse al realizar el montaje. Nardi declina toda responsabilidad por daños a personas y/o cosas, o al producto en sí, causados por un uso inadecuado del producto.

PT Mesa extensível. 140-210 x 100 x 73h cm. Material: tampo DurelTOP em polipropileno com tratamento anti-UV colorido na totalidade. Pernas em alumínio pintado. Acabamento fosco. Pés ajustáveis. Instruções de utilização: deve permanecer em solo estável e plano. Limpar com detergente suave e passar com água. Utilização: coletividade. Requer montagem. Fabricado em Italia. Resina reciclável. Produto conforme norma UNI EN 581/1/3. Aviso importante: perigo de corte e entalamento durante a instalação. A Nardi declina qualquer responsabilidade por danos a pessoas e/ou coisas, ou ao próprio produto, causados pelo uso indevido do produto.

Ref. 427

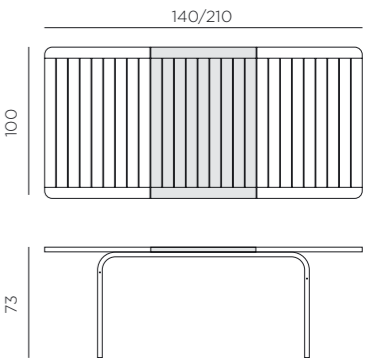















ATTENTION

IT NARDI NON RISponderà DI EVENTUALI DANNI CAUSATI IN FASE DI ASSEMBLAGGIO.
EN NARDI SHALL NOT BE HELD LIABLE FOR ANY DAMAGE CAUSED DURING ASSEMBLY OPERATIONS.
FR NARDI N'EST PAS RESPONSABLE DES DOMMAGES CAUSÉS LORS DE L'ASSEMBLAGE.
DE NARDI HÄFTET NICHT FÜR EVENTUELLE WÄHREND DER MONTAGE VERURSACHTE SCHÄDEN.
ES NARDI NO SERÁ RESPONSABLE DE LOS DAÑOS PRODUCIDOS DURANTE EL MONTAJE.
PT A NARDI NÃO SE RESPONSABILIZA POR QUAISQUER DANOS CAUSADOS DURANTE A MONTAGEM.

IMPORTANTE, CONSERVARE PER FUTURI RIFERIMENTI: LEGGERE ATTENTAMENTE. • IMPORTANT, RETAIN FOR FUTURE REFERENCE: READ CAREFULLY. • IMPORTANT-À CONSERVER POUR DE FUTURS BESOINS DE RÉFÉRENCE: À LIRE SOIGNEUSEMENT. • WICHTIG BITTE AUFMERKSAM DURCHLESEN UND GUT AUFBEWAHREN. • IMPORTANTE GUARDAR PARA FUTURAS CONSULTAS: LEER ATENTAMENTE. • IMPORTANTE CONSERVE PARA FUTURAS REFERÊNCIAS: LEIA ATENTAMENTE.

COMPONENTI, COMPONENTS, COMPOSANTS, KOMPONENTEN, COMPONENTES, COMPONENTES.

A	B	C	D	E	F	G
						
M6 x 45	M6 x 25	M6 x 18				
8	4	8	1	4	4	1

H	I	J	K	L	M	N
						
2	2	4	2	1	2	2

ASSEMBLAGGIO, ASSEMBLY, ASSEMBLAGE, MONTAGE, ENSAMBLAR, MONTAGEM.

